

Informatika v javni upravi 2014: "Izza oblaka sonce"



Vzpostavitev Državnega računalniškega oblaka

Marko Ambrož, Mišo Vukadinović

Ministrstvo za javno upravo

08. 12. 2014



Oblak?

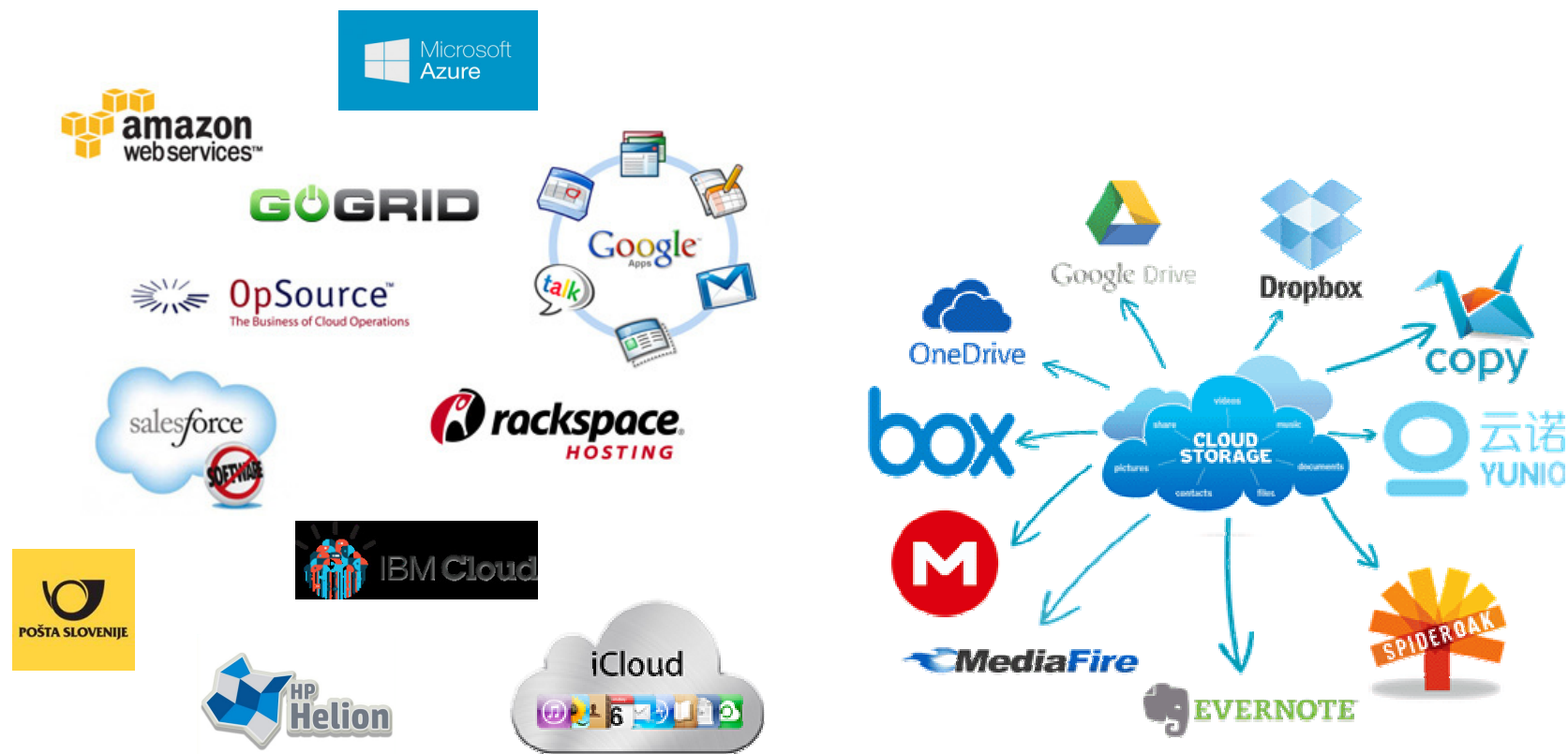



Zasebni oblak

DRO predstavlja računalniško infrastrukturo, ki je v lasti države in jo upravlja država.

Na tej infrastrukturi se izvajajo storitve, ki uporabljajo občutljive, osebne in druge podatke in informacije, ki jih država ne želi shranjevati izven svojega okolja.

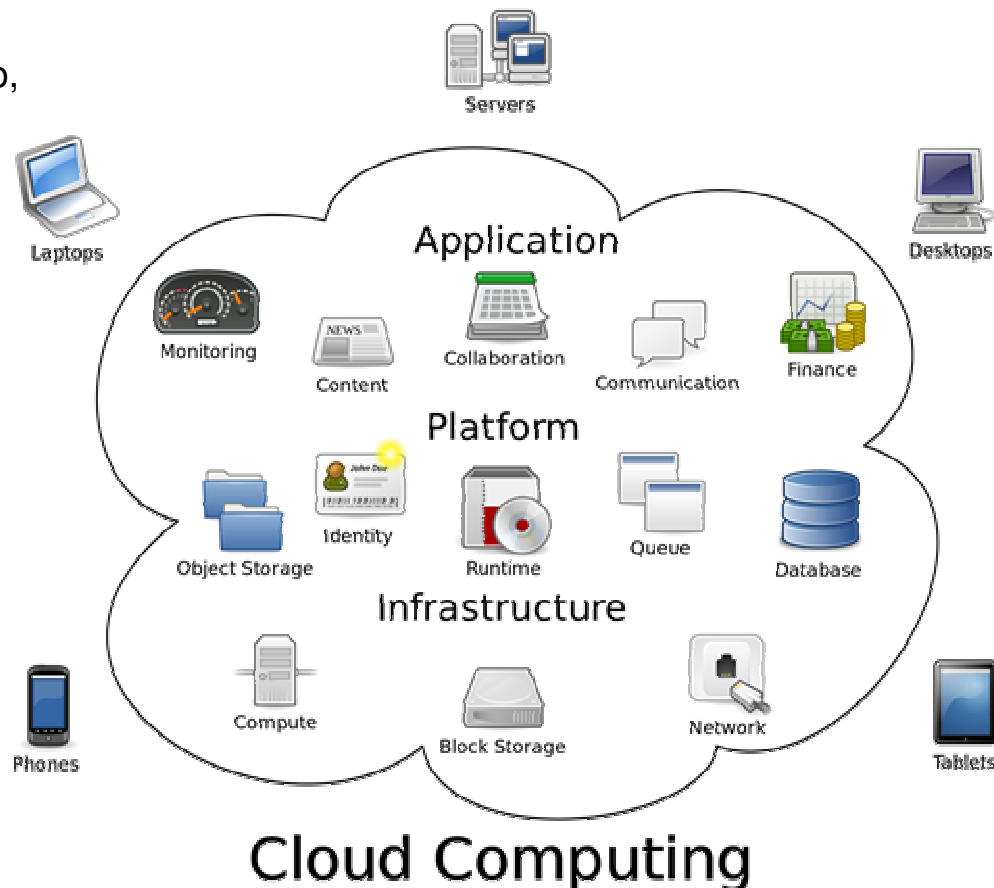



KP, analiza 2014





Različni sistemi in načini virtualizacije

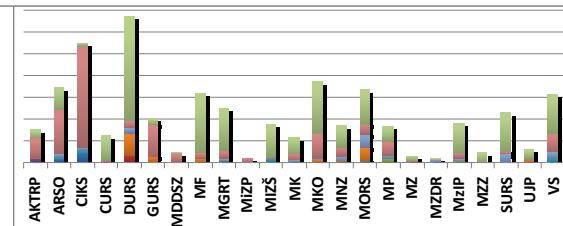
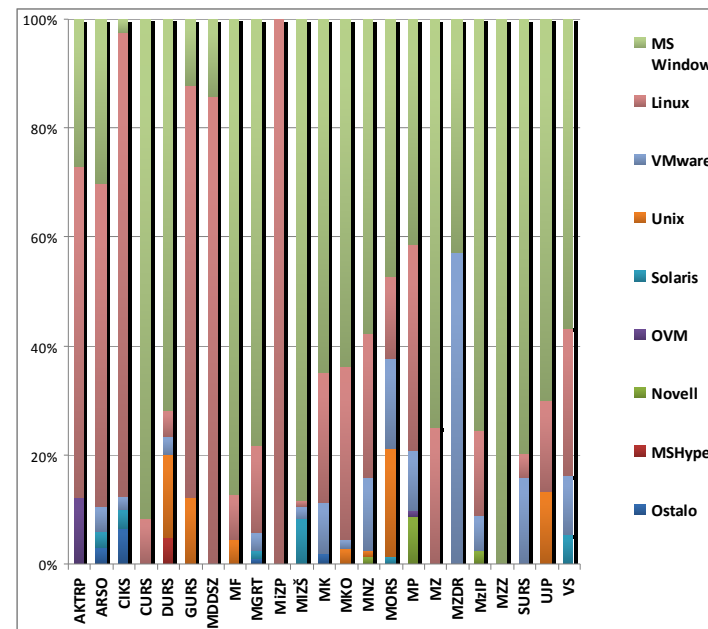
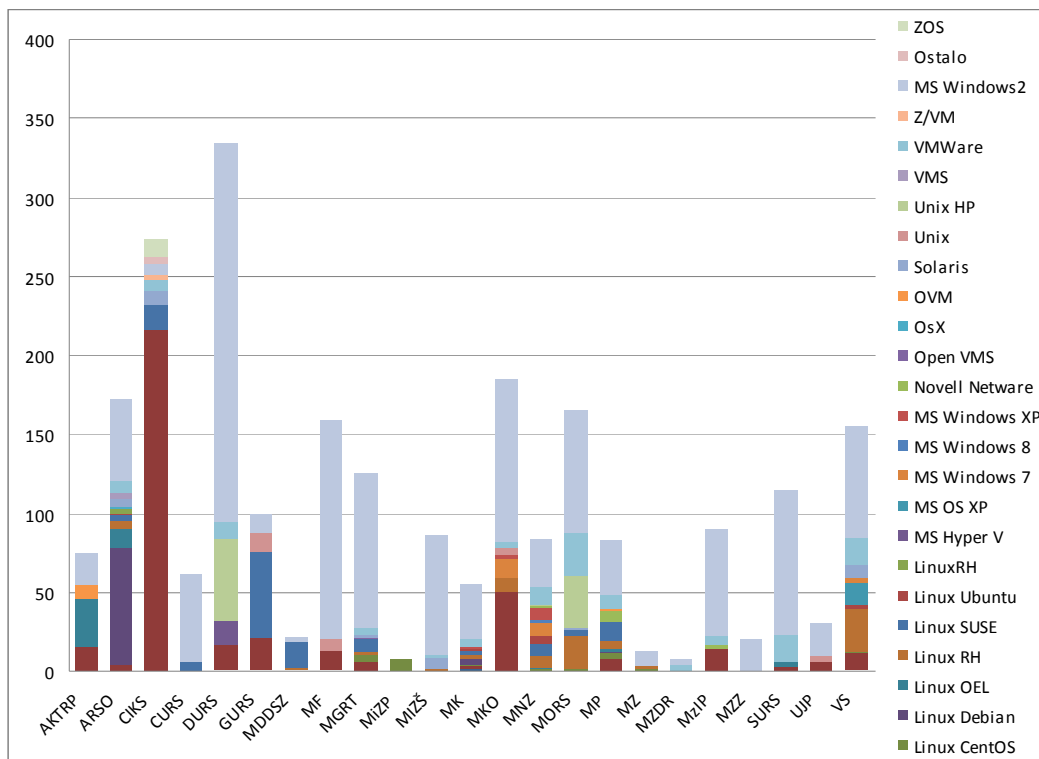



Premajhen delež virtualizacije

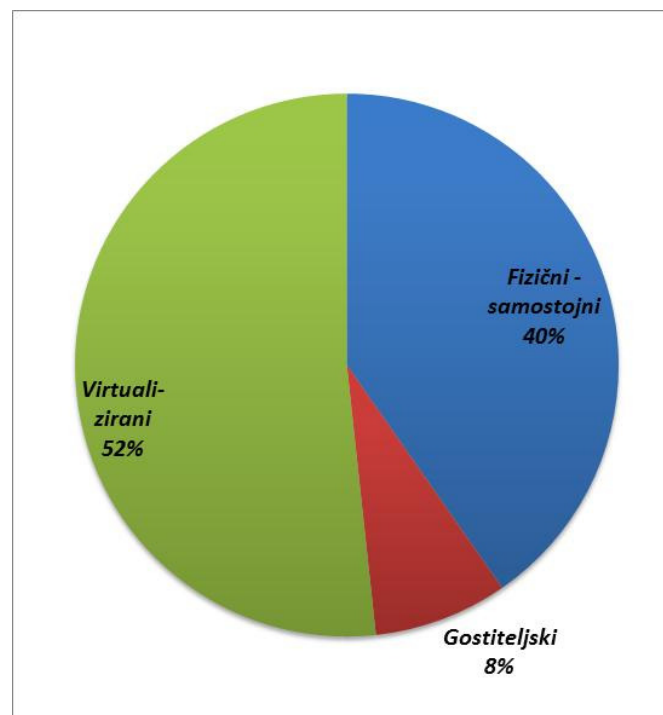
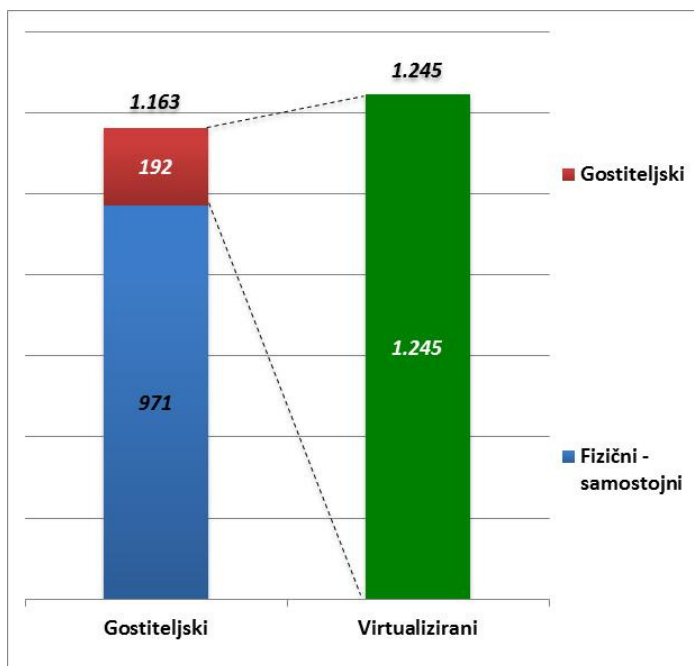



Stara oprema, drago vzdrževanje

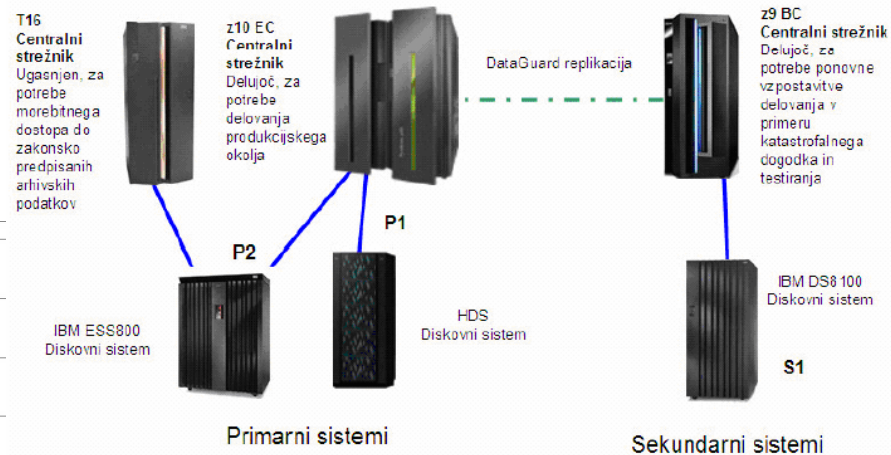
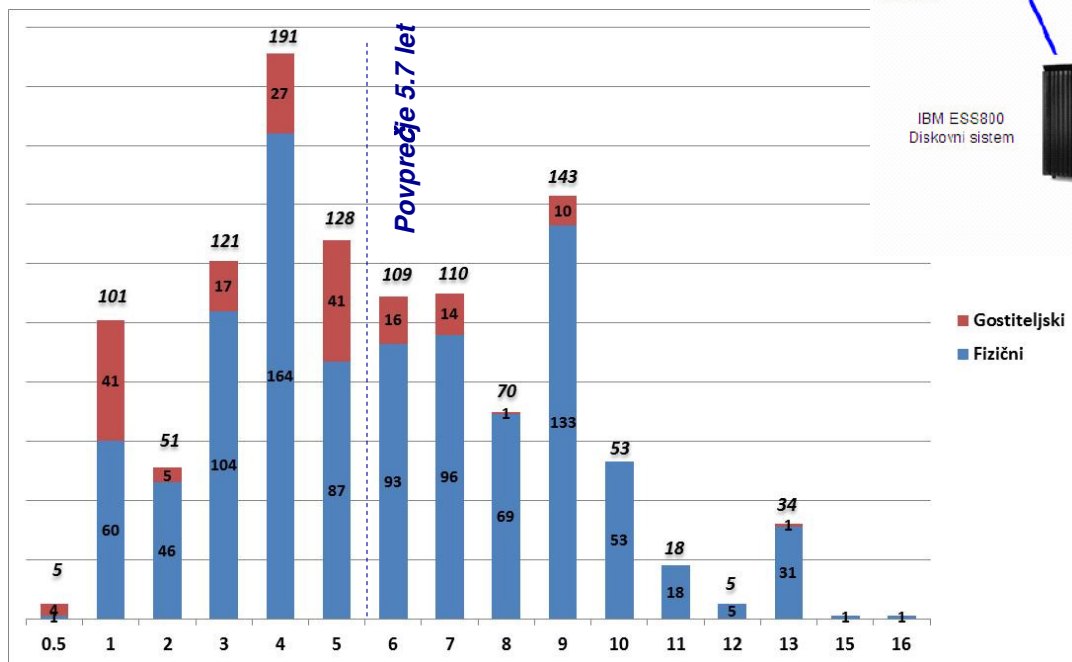



Urejanje, posodabljanje, učinkovito upravljanje





Nova infrastruktura iz EU sredstev

Prehod iz centralnih računalnikov na okolje, sestavljeno iz standardnih računalniških komponent (Intel strežniki, zmogljivi diskovni podsistemi, namenski sklopi za učinkovito izvajanje podatkovnih zbirk).
 Konsolidacija obstoječih podatkovnih centrov na novi oblaki infrastrukturi.

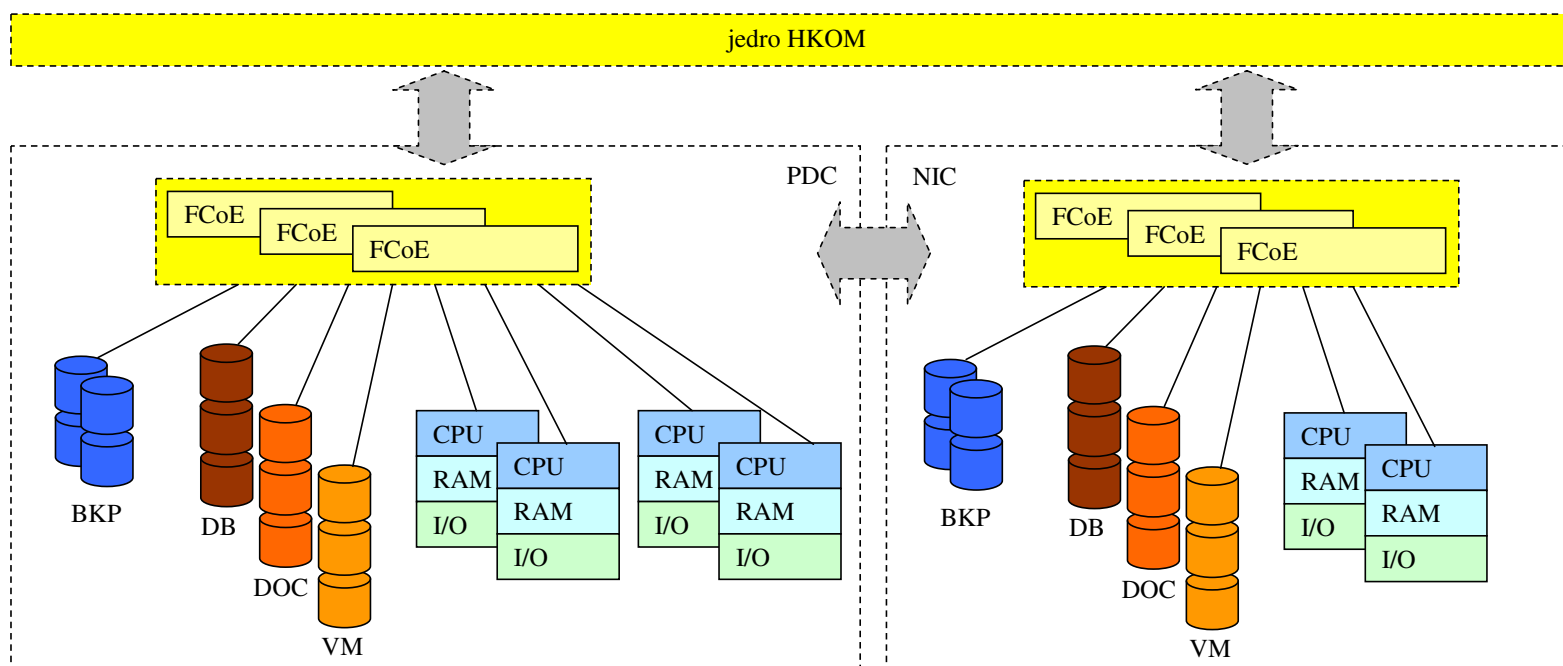



Virtualizacija strežniških, diskovnih in mrežnih virov

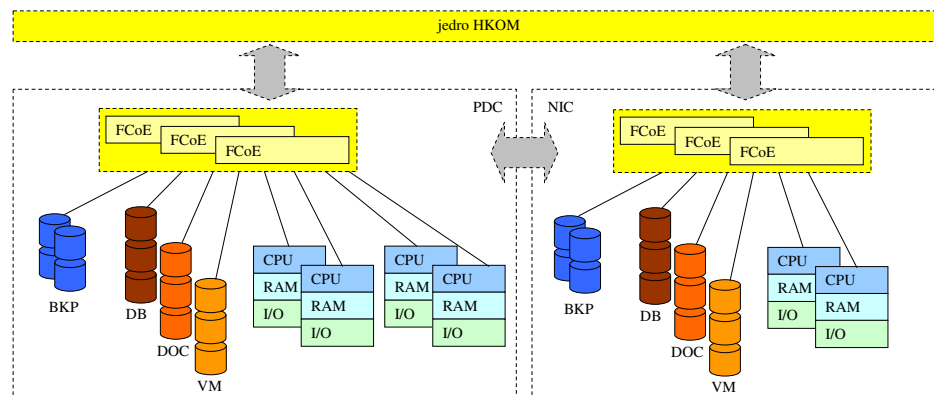

avtomatizacija, orkestracija

VM VM VM VM VM VM VM VM konsolidacija

virtualizacija 1

virtualizacija 2

virtualizacija 3

varnost
 zmogljivost
 zanesljivost

urejenost
 učinkovitost
 ekonomičnost



Inovativnost, obláčnost

IaaS

PaaS

SaaS

skupni gradniki

objektna hramba

varnostno kopiranje

gostovanje spletišč in sistemov

razvojna platforma

podatkovne zbirke

storitve varnosti

referenčna arhitektura

standardizacija

odprte tehnologije

odprti podatki

OpenStack

vsebniki (containers)

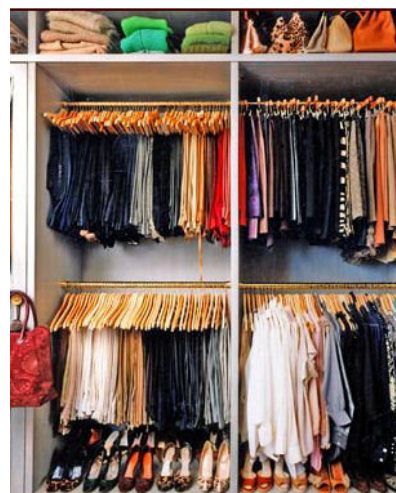
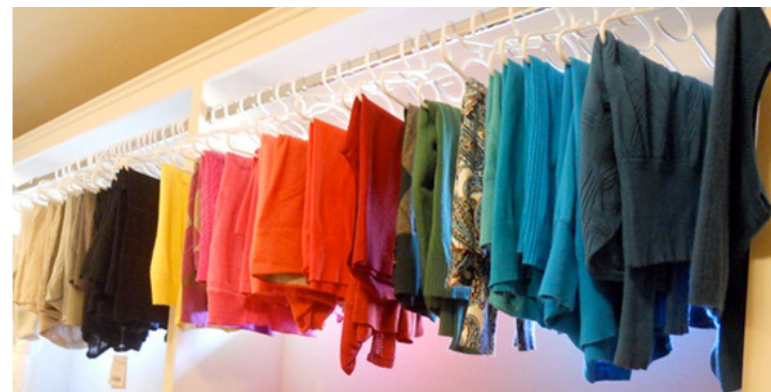



DRO

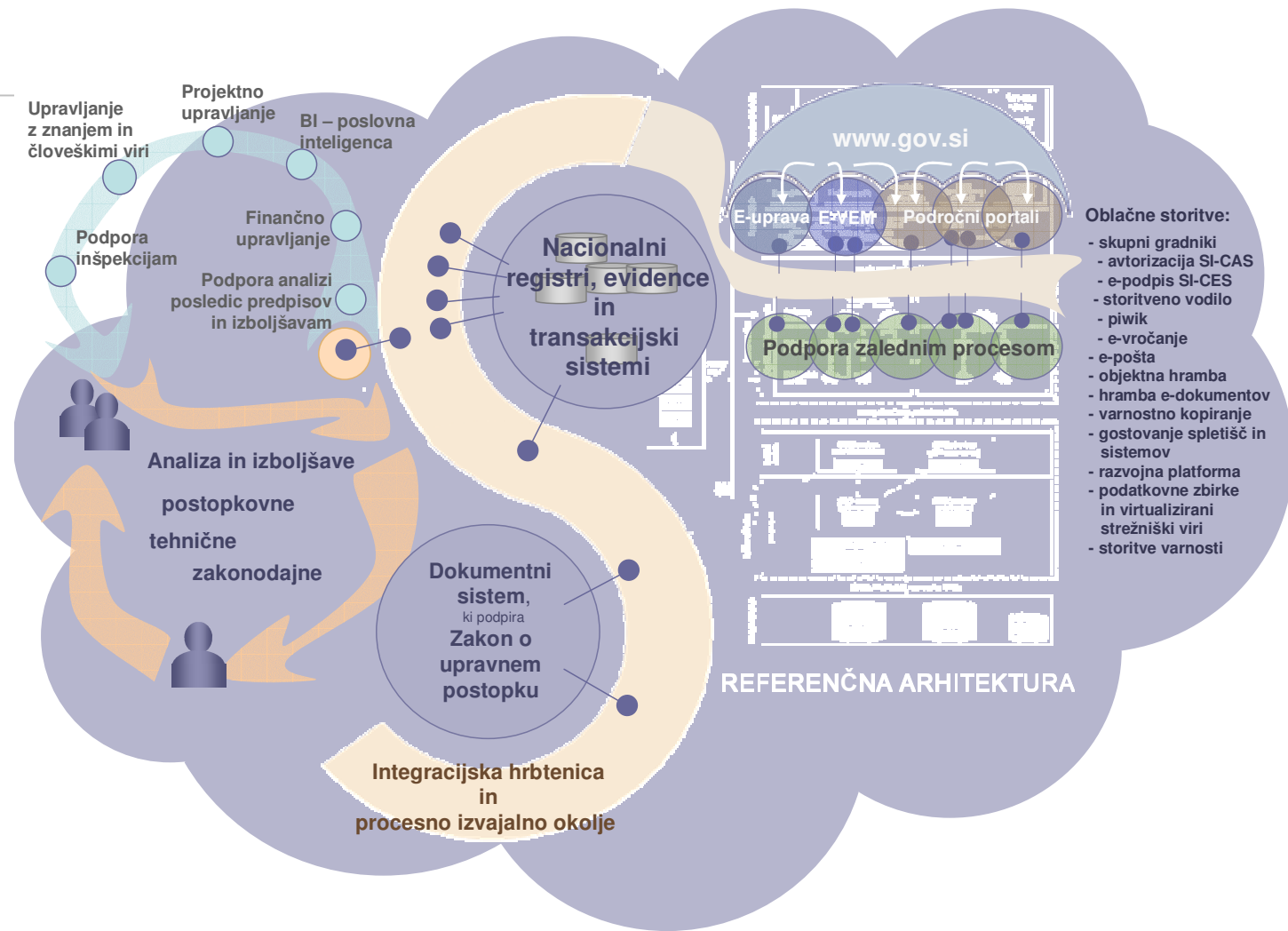



Nov model razvoja

Uporaba referenčne arhitekture

Skupni horizontalni gradniki

Uporaba vzorcev

Zvezna integracija

Razvojna platforma kot storitev

<https://nio.gov.si/nio/asset/referencna+arhitektura>

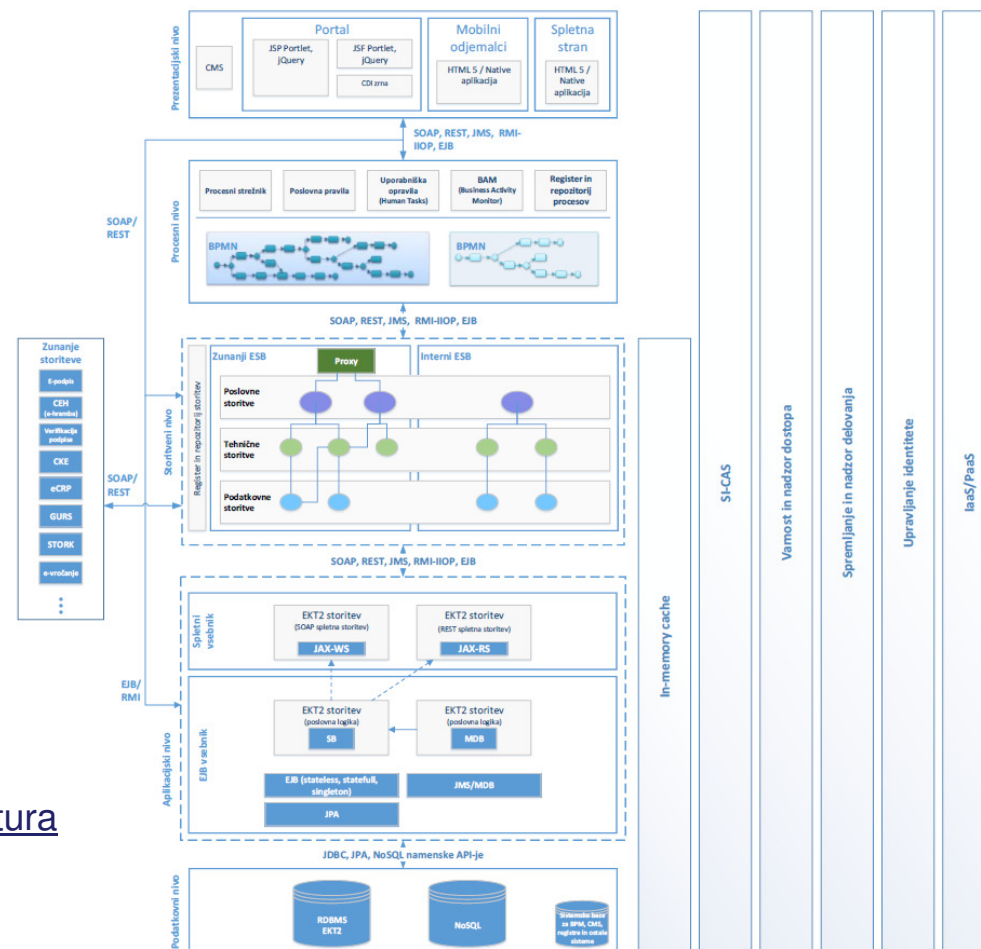

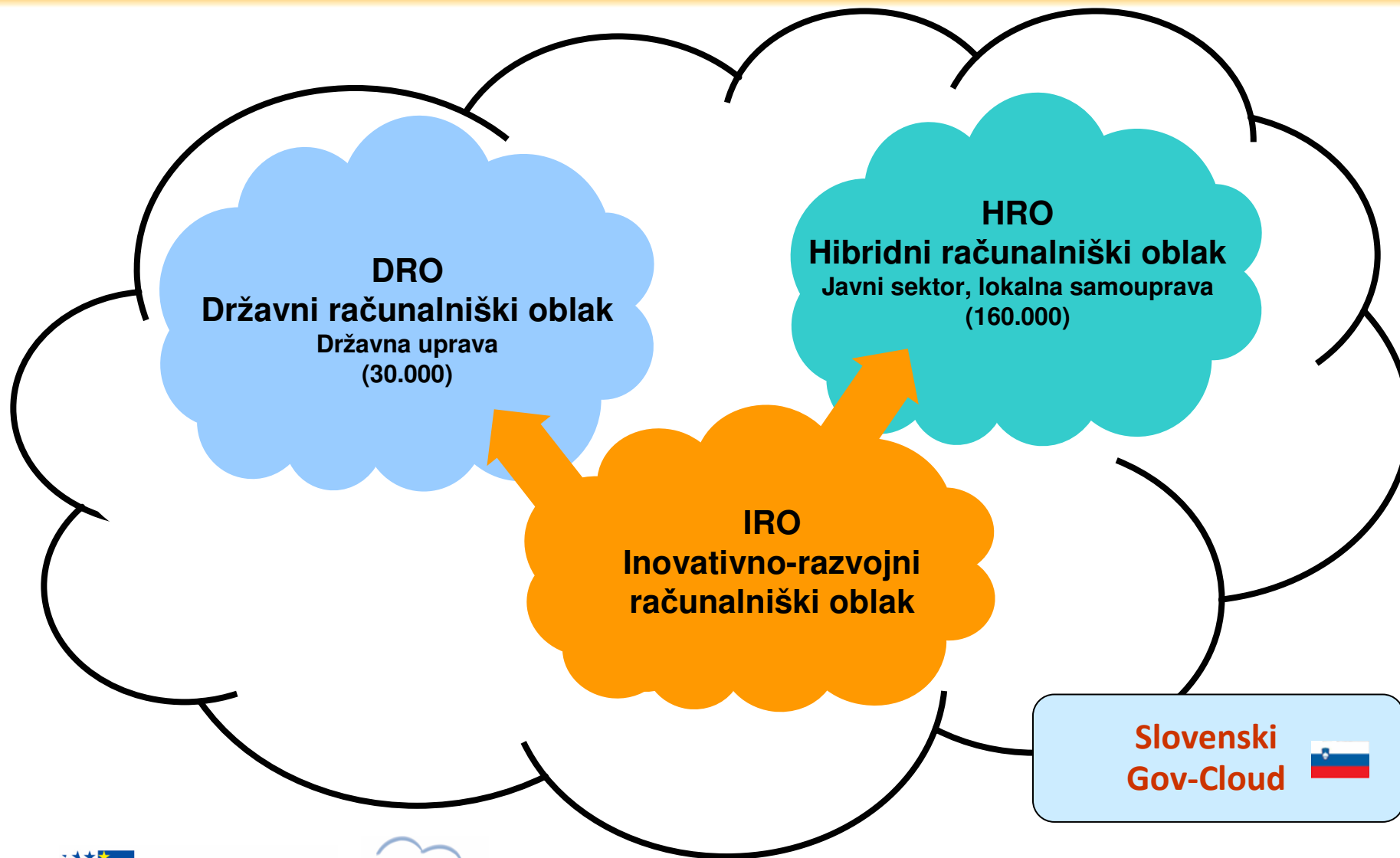

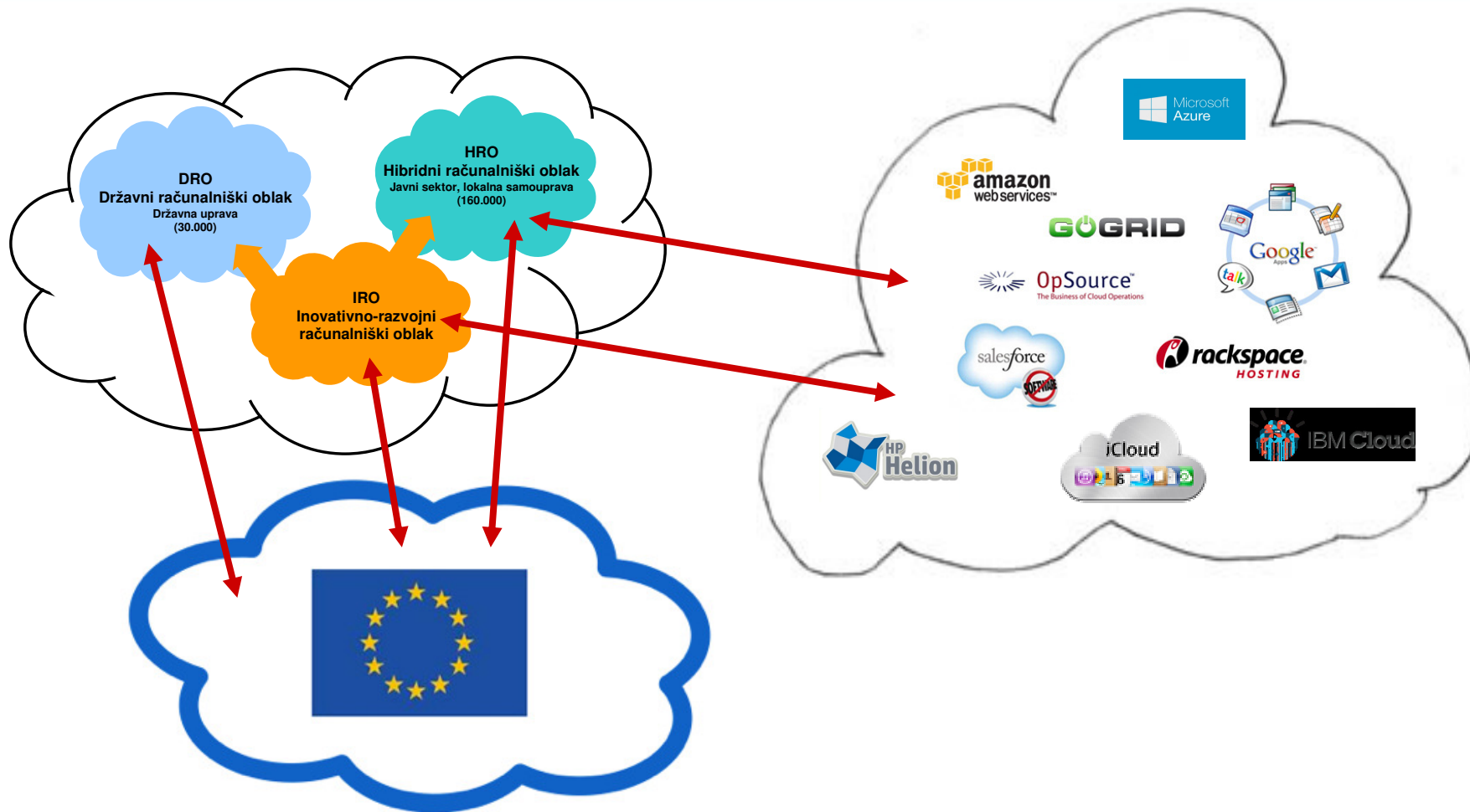

Federated EU Cloud, common services catalogue



Informacije o DRO / dro.gov.si

Vrednost projekta: 14.427.360 EUR (EU 85%, SLO 15%)

Objave javnih naročil - januar 2015

Vzpostavitev DRO, zaključek investicijskega projekta - 30. 11. 2015

Projekt je financiran iz naslova dodatnih pravic porabe Evropskega sklada za regionalni razvoj, Operativni program krepitve regionalnih razvojnih potencialov za obdobje 2007-2013, prednostne usmeritve 2.2 Informacijska družba.

Spletna stran: dro.gov.si

